



# AZEK<sup>®</sup> Closed-Joint Cladding Installation Guide

<b>Tools Required</b> .....	<b>2</b>
<b>Product</b> .....	<b>3</b>
<b>Installation Preparation</b> .....	<b>3</b>
<b>Expansion and Contraction</b> .....	<b>4</b>
<b>Fasteners</b> .....	<b>4</b>
<b>Fastening Schedule</b> .....	<b>5</b>
<b>Furring Strips and First Course (Horizontal Application)</b> .....	<b>6</b>
<b>Fasten Board and Spacing (Horizontal Application)</b> .....	<b>7</b>
<b>Butt Joints and Adjoining Walls (Horizontal Application)</b> .....	<b>7</b>
<b>Windows &amp; Doors (Horizontal Application)</b> .....	<b>8</b>
<b>Furring Strips and First Course (Vertical Application)</b> .....	<b>9</b>
<b>Fasten Board and Spacing (Vertical Application)</b> .....	<b>10</b>
<b>Butt Joints and Adjoining Walls (Vertical Application)</b> .....	<b>10</b>
<b>Windows &amp; Doors (Vertical Application)</b> .....	<b>11</b>
<b>Storage &amp; Handling, Considerations</b> .....	<b>12</b>
<b>Care and Maintenance</b> .....	<b>13</b>

**TOOLS REQUIRED**

AZEK® Closed-Joint Cladding should be installed using good building principals and in accordance with local building codes and the installation guidelines included below. AZEK accepts no liability or responsibility for the improper installation of this product. AZEK Closed-Joint Cladding may not be suitable for every application and it is the sole responsibility of the installer to be sure any products are a fit for the intended use. Since all installations are unique, it is also the installer's responsibility to determine specific requirements for each application. AZEK recommends that all applications be reviewed by a licensed architect, engineer or local building official before installation. If you have any questions or need further assistance, please call AZEK Customer Service at 1-877-ASK-AZEK (1-877-275-2935) or visit our website at [www.AZEKexteriors.com](http://www.AZEKexteriors.com).

**Tools Required**

AZEK Closed-Joint Cladding can be installed with a minimum number of readily available tools. Many other tools are available that can be used for installation. All tools should be used per applicable manufacturers' instructions. Some of the basic tool requirements:

- Cordless Driver
- Chalk Line
- Tape Measure
- Jig Saw
- Level
- Carpenter Square
- Spacing Tools
- Miter Saw
- Chalk Line/String
- Safety Glasses

Use the jigsaw to cut around obstruction. For best results when cutting, use a power miter saw with a fine-toothed, carbide tipped finish trim blade (12" - 100 tooth min. or 10" - 80 tooth min. When working with AZEK products be sure to wear proper clothing and safety equipment. Safety glasses should be used during the entire installation process. Do not use any cordless saws.

**Extreme Heat Warning**

Be aware of excessive heat on the surface of AZEK products from external sources, such as but not limited to, fire or reflection of sunlight from energy-efficient window products. Low-emissivity (Low-E) glass can potentially harm AZEK products. Low-E glass is designed to prevent passive heat gain within a structure and can cause unusual heat build-up on exterior surfaces. This extreme elevation of surface temperatures, which exceeds that of normal exposure, can possibly cause AZEK products to melt, sag, warp, discolor, increase expansion/contraction, and accelerate weathering.

Current or potential AZEK customers that have concerns about possible damage by Low-E glass should contact the manufacturer of the product which contains Low-E glass for a solution to reduce or eliminate the effects of reflected sunlight.

**Non Load Bearing Only**

AZEK Closed-Joint Cladding is a non-structural cladding and cannot be used as a load bearing component of the wall.

**Important**

The outside wall of structure must be weather tight and up to code with a proper weather-resistant barrier or other weather-proofing product prior to installing AZEK Closed-Joint Cladding. AZEK Closed-Joint Cladding is not designed for nor intended to prevent water infiltration. It is the sole responsibility of the engineer, architect, and installer to ensure the design and installation of the wall and building are code compliant and weather-resistant behind AZEK Closed-Joint Cladding.

**Install Guide for Residential Applications Only**

This Installation Guideline is intended solely for the purpose of providing guidance in installing AZEK Closed-Joint Cladding in Residential type V-B construction applications where it is deemed suitable by the installer, architect, engineer or local building code official, and meets all local building codes. It does not purport to provide guidance for installing AZEK Closed-Joint Cladding in multi-family or commercial applications.

**Products**

**AZEK Closed-Joint Cladding Products**

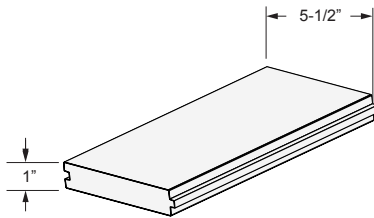
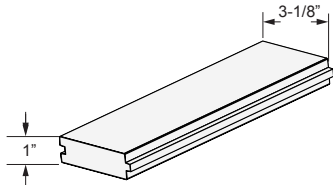

CLOSED-JOINT CLADDING PRODUCTS	5 1/2" WIDTH		3 1/8" WIDTH		
	12'	16'	10'	12'	16'
Standard Thickness 1"					
COASTLINE <sup>®</sup>	•	•		•	•
WEATHERED TEAK <sup>®</sup>	•	•		•	•
MAHOGANY	•	•		•	•
DARK HICKORY	•	•		•	•
OYSTER <sup>®</sup>				•	•
MORADO <sup>®</sup>				•	•
SILVER OAK <sup>®</sup>				•	•
BROWNSTONE			•	•	•
SLATE GRAY			•	•	•

**Installation Preparation**

Follow these installation preparation best practices to ensure a successful installation of AZEK Closed-Joint Cladding:

- Prior to installation, be sure the wall is structurally sound, weather-tight, stud locations are identified and marked, and any protruding screws, nails, or staples are removed or pounded in.
- Ensure the finished installation is flat and even by using shims or a planer on the 2x4 furring strips. AZEK Closed-Joint Cladding will conform to undulations in the wall.
- Use maximum spacing between furring strips of 16" on-center.
- AZEK Closed-Joint Cladding is a one-sided product and must be installed with the grain side out.

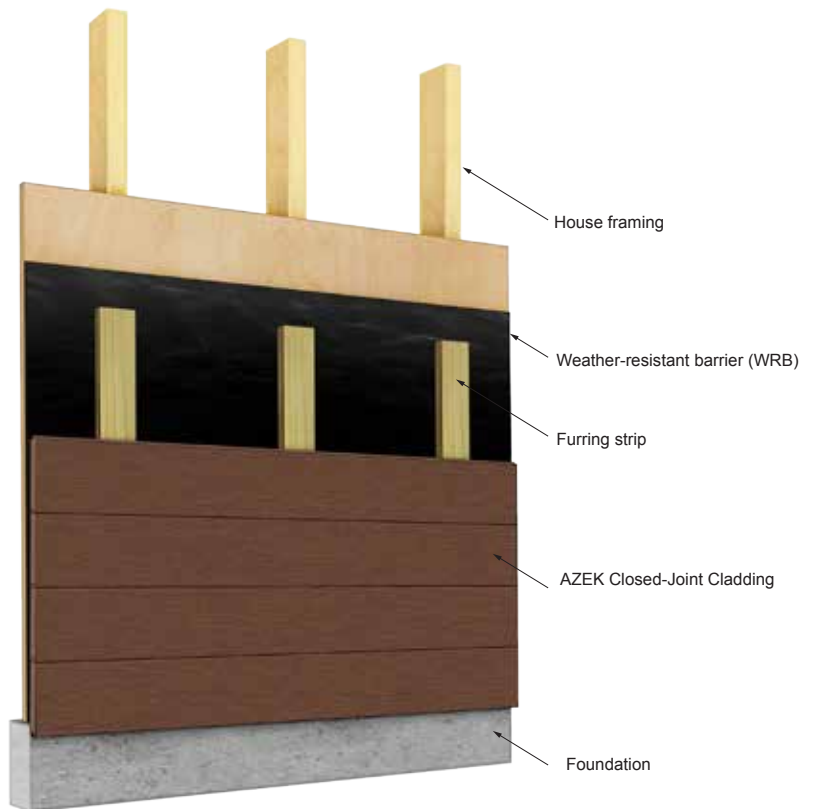

## Expansion and Contraction

AZEK Closed-Joint Cladding will expand and contract with changes in temperature, unlike wood which fluctuates with moisture. The expansion and contraction encountered may result in slight gaps at the board ends or splice joints. To help minimize these gaps, follow these best practices:

- Install the AZEK Closed-Joint Cladding boards when they are as cool as possible. Avoid leaving them in direct sunlight prior to installation.
- Install boards cut to length immediately after cutting them.
- Cut all factory edges to ensure a clean, square cut, and install but joints tight at all temperatures. Do not leave a gap.
- Leave a minimum 1/8" gap around all protrusions, boxes and fixtures. When notching or cutting out product to fit around the protrusions create a radius corner to limit stress. Install 2x4 furring strips around all protrusions and fasten the Cladding boards within 1/2" of cut edges.

## Fasteners

- Use 2 1/2" and 2" Cortex<sup>®</sup> hidden fasteners available in color matching, or stainless steel fasteners for Vintage, Harvest and Arbor are available (use 2" when installing into 2x4 pressure treated furring strips over a masonry wall)
- For salt water coastal applications, we suggest using the above minimum fastener requirements in 316 stainless steel.
- AZEK does not recommend any fastener that is not explicitly stated in this installation guide. Use of any alternative fastener does not void the AZEK warranty; however, if a cladding failure is caused by using one of these alternative fastening methods, any corresponding claims will be denied.
- AZEK strongly recommends using the fasteners outlined above. Other fasteners have not been tested and may limit the performance of the product and installation.

## Fastening Schedule

### 3-1/8" Width Fastening

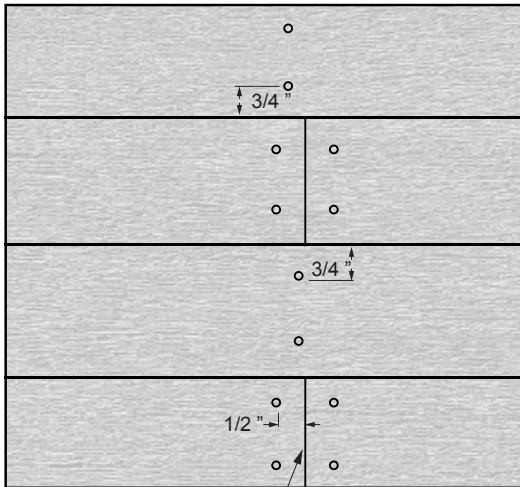

Install butt joints tight

#### Main Course:

- Use a minimum of 2 fasteners into each 16" on-center furring strip between the ends of the board
- Position fasteners 3/4" from each side of the board

#### Board Ends:

- Use a minimum of 2 fasteners into the furring strip on the ends of each board
- Fasteners need to be placed within 1/2" from the ends, with 2 fasteners 3/4" from the edges
- Drive fasteners perpendicular into furring strips. Do not angle.

### 5-1/2" Width Fastening

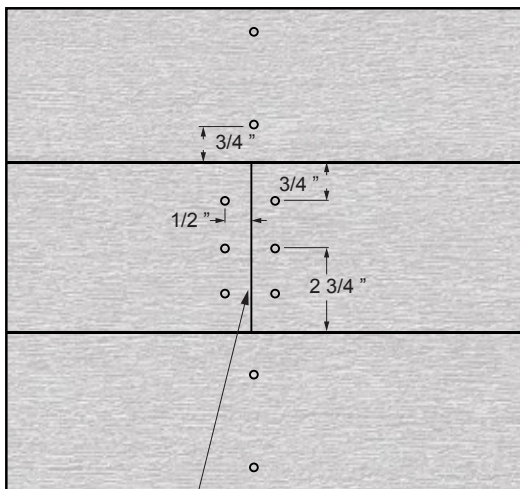

Install butt joints tight

#### Main Course:

- Use a minimum of 2 fasteners into each 16" on-center furring strip between the ends of the board
- Position fasteners 3/4" from each side of the board

#### Board Ends:

- Use a minimum of 3 fasteners into the furring strip on the ends of each board
- Fasteners need to be placed within 1/2" from the ends, with 2 fasteners 3/4" from the edges and 1 fastener in the middle.
- Drive fasteners perpendicular into furring strips. Do not angle.

**1**

**Furring Strips**

**HORIZONTAL APPLICATION**

Weather-resistant barrier (WRB)

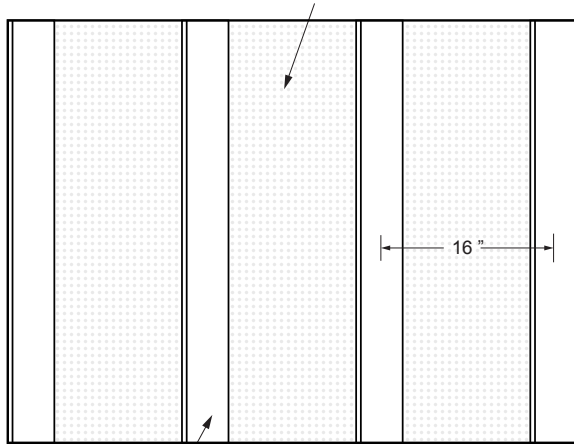

Pressure treated 2x4 (1-1/2" thick)

- Attach the pressure treated 2x4 furring strips with the 3.5" dimension flat against the WRB or weather-tight wall.
- Use a maximum spacing of 16" on-center between furring strips.
- For wood framing, secure the furring strips into studs using suitable fasteners.
- For masonry construction, secure the furring strips to the masonry wall with suitable masonry fasteners.



**Important**

The wall or furring strips may move over time due to settling of the ground or building, age of the building, or expansion and contraction from moisture or temperature. To avoid wicking water into furring strips leave a gap to grade or use furring strips approved for ground contact.



**Important**

After the furring members are installed, run string lines to ensure the faces of the furring strips are in plane. AZEK Closed-Joint Cladding will contour to undulation in the furring strips. It may be necessary to shim or plan the furring strips due to thickness variations in lumber, or variations in the wall to which the furring strips are attached.

**2**

**Starting Course & Fastening**

**HORIZONTAL APPLICATION**

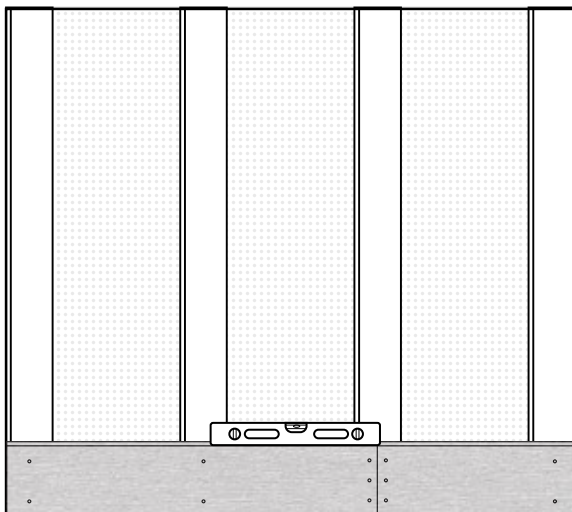

- Choose the starting location of the first course. Position the board with the tongue facing up and ensure it is level prior to fastening.
- Use the recommended fasteners and fastener lengths, with a minimum penetration into the furring strips of 1-1/4".
- The multi-width offering of AZEK Closed-Joint Cladding has varying fastening schedules outlined on pages 5. It is important to fasten each width according to this fastening schedule.
- Fasten from the center out, or from one end to the other. Do not fasten each end and then fasten to the middle.
- Install all butt joints tight no matter the temperature.
- Frequently check for level as additional boards are installed up the wall.

**3**

**Spacing of Boards**

**HORIZONTAL APPLICATION**



- Place the next course of Cladding with the groove setting onto the tongue of the course below.
- Fasten the course as outlined in the fastening schedule on page 5.
- To minimize the stress on individual furring strips, stagger butt joints across multiple furring strips. For best practices, stagger butt joints 32" from one course to the next.
- If a butt joint is necessary, always center it over a 2x4 furring strip.

**4**

**Adjoining Walls**

**HORIZONTAL APPLICATION**

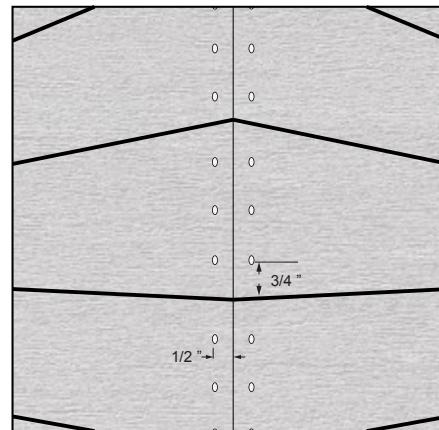
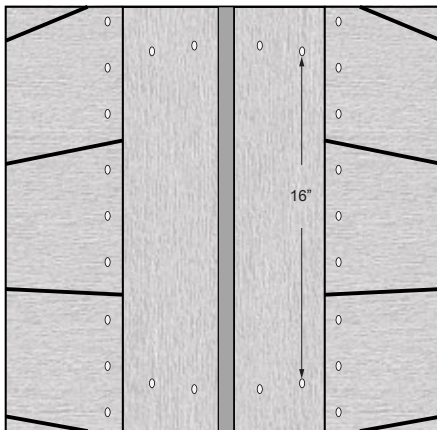

- For use on adjoining walls, but sure to check the level of each course frequently.
- AZEK Closed-Joint Cladding can be installed with mitered corners. For best results, build out the corners with additional furring strips so the cladding can be fastened close to the ends.
- Additional furring may also be needed around wall openings such as doors and windows.
- Vertical outside corners may be constructed using AZEK Open-Joint Cladding boards (square shouldered) running vertically, or with AZEK Trim, AZEK Cornerboards, or aluminum corner profiles.
- Vertical outside corners created with Cladding, Trim or Cornerboards must be furred out and fastened with 2 fasteners every 16".

**5** Trimming Windows & Doors

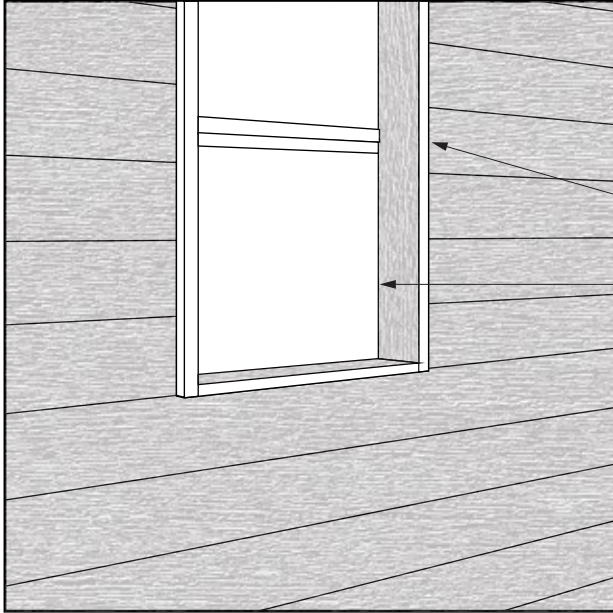

- AZEK Open-Joint Cladding boards or AZEK Trim can be used as a casing around windows or doors. Using Closed-Joint Cladding boards will show an exposed groove.

Factory edge facing outwards

Rip cut edge facing inwards

- The example shown on the left is using an AZEK Open-Joint Cladding board (square shouldered) that was rip cut to width as a side jam extension. The factory edge is installed facing outward and the rip cut edge toward the interior of the building (not exposed).
- Window jam extensions created with Cladding or Trim must be fastened with 2 fasteners every 16" and within 1/2" of each end cut.



**1**

**Furring Strips**

**VERTICAL APPLICATION**

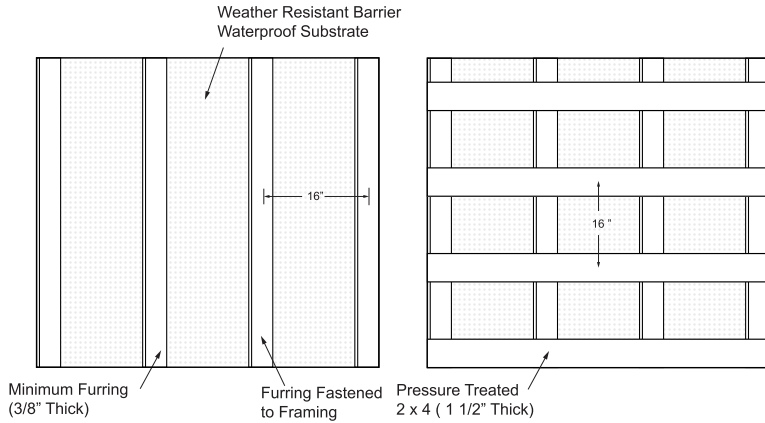

- First, attach the 3/8" weather-resistant furring strips vertically to the WRB or weather-tight wall.
- Use a maximum spacing of 16" on-center between furring strips.
- After initial vertical furring strips are installed, attach treated 2x4 furring strips horizontally through the vertical furring strips.
- For the horizontal furring strips use a maximum spacing of 16" on center.
- For wood framing, secure the furring strips into studs using suitable fasteners and minimum 1-1/4" penetration into the stud.
- For masonry construction, secure the furring strips to the masonry with a minimum 3/4" penetration into the masonry.



**Important**

The wall or furring strips may move over time due to settling of the ground or building, age of the building, or expansion and contraction from moisture or temperature. To avoid wicking water into furring strips leave a gap to grade or use furring strips approved for ground contact.



**Important**

After the furring members are installed, run string lines to ensure the faces of the furring strips are in plane. AZEK Closed-Joint Cladding will contour to undulation in the furring strips. It may be necessary to shim or plan the furring strips due to thickness variations in lumber, or variations in the wall to which the furring strips are attached.

**2**

**Starting Course & Fastening**

**VERTICAL APPLICATION**

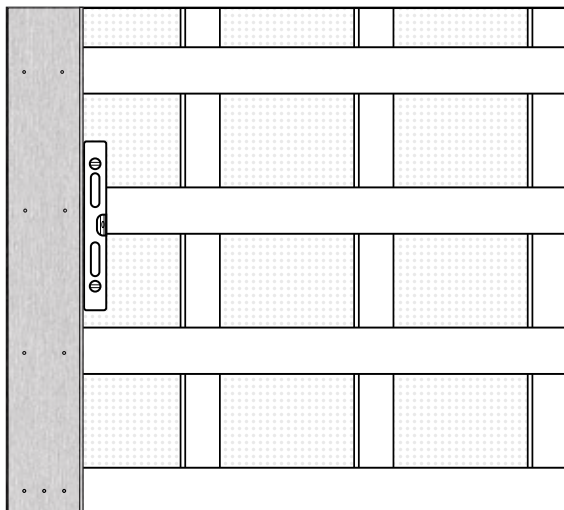

- Choose the starting location of the first course. Position the board with the tongue facing up and ensure it is level prior to fastening.
- Use the recommended fasteners and fastener lengths, with a minimum penetration into the furring strips of 1-1/4".
- The multi-width offering of AZEK Closed-Joint Cladding has varying fastening schedules outlined on pages 5. It is important to fasten each width according to this fastening schedule.
- Fasten from the center out, or from one end to the other. Do not fasten each end and then fasten to the middle.
- Install all butt joints tight no matter the temperature.
- Frequently check for level as additional boards are installed up the wall.

**3**

**Spacing of Boards**

VERTICAL APPLICATION

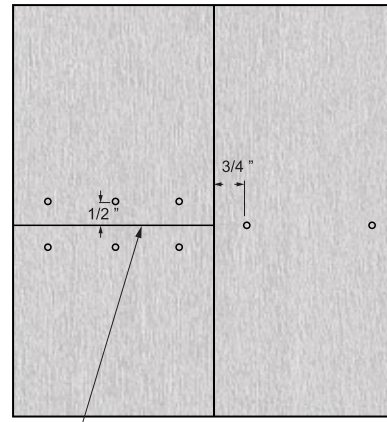
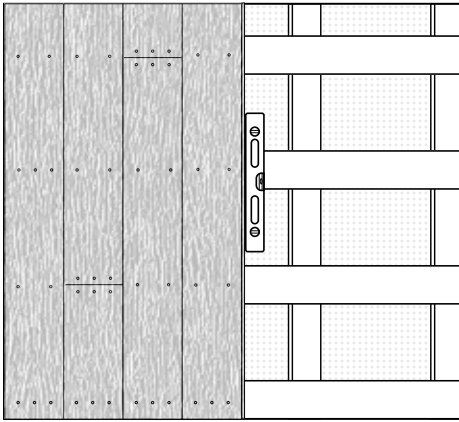

Install butt joints tight

- Place the next course of Cladding with the groove setting onto the tongue of the course below.
- Fasten the course as outlined in the fastening schedule on page 5.
- To minimize the stress on individual furring strips, stagger butt joints across multiple furring strips. For best practices, stagger butt joints 32" from one course to the next.
- If a butt joint is necessary, always center it over a 2x4 furring strip.

**4**

**Adjoining Walls**

VERTICAL APPLICATION

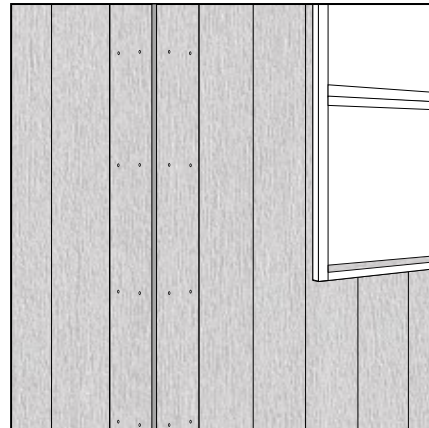
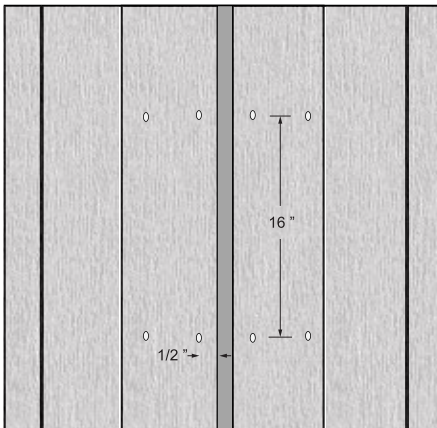

- For use on adjoining walls, but sure to check the level of each course frequently.
- AZEK Closed-Joint Cladding can be installed with mitered corners. For best results, build out the corners with additional furring strips so the cladding can be fastened close to the ends.
- Additional furring may also be needed around wall openings such as doors and windows.
- Vertical outside corners may be constructed using AZEK Open-Joint Cladding boards (square shouldered) running vertically, or with AZEK Trim, AZEK Cornerboards, or aluminum corner profiles.
- Vertical outside corners created with Cladding, Trim or Cornerboards must be furred out and fastened with 2 fasteners every 16".

## 5 Trimming Windows & Doors

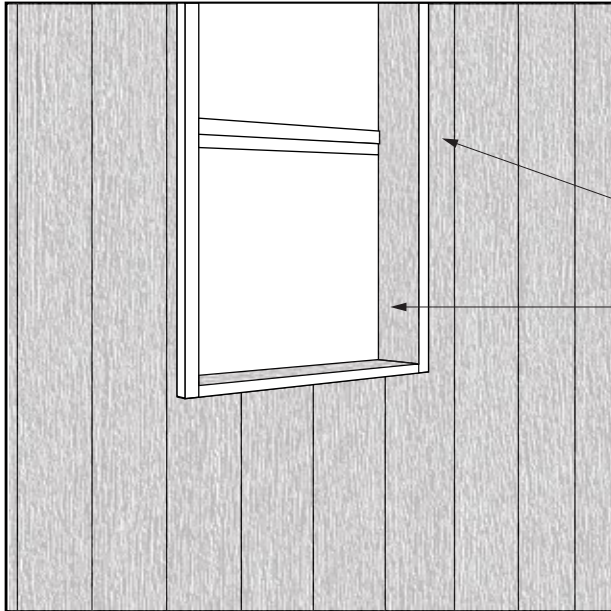

- AZEK Open-Joint Cladding boards or AZEK Trim can be used as a casing around windows or doors. Using Closed-Joint Cladding boards will show an exposed groove.

Factory Edge Facing Outwards

Rip Cut Edge Facing Inwards

- The example shown on the left is using an AZEK Open-Joint Cladding board (square shouldered) that was rip cut to width as a side jam extension. The factory edge is installed facing outward and the rip cut edge toward the interior of the building (not exposed).
- Window jam extensions created with Cladding or Trim must be fastened with 2 fasteners every 16" and within 1/2" of each end cut.

### Storage & Handling

- Store AZEK Closed-Joint Cladding on a flat and level surface.
- Store products in a cool, shady area prior to installation.
- Do not stack bundles over 8 units high.
- Always leave factory applied protective wrap. If stored outdoors, the product must be covered with non-translucent material.
- Use care when handling product with a forklift as forks can easily damage the material.
- If banding is used, use protective corners to prevent indents from the bands.
- Avoid storing AZEK Closed-Joint Cladding in areas of excessive heat, such as on top of asphalt.



### Excessive Construction Debris

It is important during construction that AZEK Closed-Joint Cladding products stay clear from excessive build-up of dirt, sand, and dust from tile, concrete, landscape blocks, or any other masonry products. If these materials are not removed immediately, the cladding surface will become difficult to clean and can potentially damage the cladding's surface finish.

Do not use AZEK Closed-Joint Cladding products as a work surface.

If a build-up does occur please refer to the Care and Cleaning section in the installation guidelines or website [www.AZEKexteriors.com](http://www.AZEKexteriors.com).

### Considerations

- Depending on the environmental conditions, AZEK Closed-Joint Cladding colors may appear to lighten over time as part of a natural weathering process.
- Please be aware that excessive heat build on the surface of AZEK products from external sources such as, but not limited to, fire or reflection of sunlight can potentially lead to damage. For example, sunlight which may be reflected by low-emissivity (Low-E) glass can potentially lead to damage of exterior building products, including AZEK Closed-Joint Cladding and AZEK Trim, due to elevation of surface temperatures which far exceed that of normal exposure of the same materials to direct sunlight. Possible damage by such reflected concentrated light may include melting, sagging, warping, distortion, surface discoloration, increased expansion or contraction, and unusual weathering.
- Static build-up is a natural occurring phenomenon that can occur with many plastic-based products including PVC Cladding. It could occur with AZEK products under the right conditions.
- Although AZEK Closed-Joint Cladding products are cooler to the touch than many other cladding products in similar colors, all cladding products will get hot in the sun. Additionally, generally speaking, the darker the color, the hotter it will feel.
- Always remove job-site dust, clay, dirt, mud, and other construction products from AZEK Closed-Joint Cladding quickly. Do not allow construction dirt and debris to sit on the surface.
- **IMPORTANT:** Do not allow airborne dust from concrete, landscape blocks, or any masonry products to accumulate on the AZEK Closed-Joint Cladding surface as it may damage the surface. Do not cut any products on or near AZEK Closed-Joint Cladding.

## Care & Maintenance

To keep your AZEK Closed-Joint Cladding looking its best:

- Some products, such as sunblock or insect repellent, contain chemicals that may alter the surface of AZEK Closed-Joint Cladding and AZEK Trim. Check product labels and consult with the manufacturer as to product compatibility with plastic materials prior to use on or near AZEK Closed-Joint Cladding or Trim products.
- Do not get any PVC glue or similar product on the surface of any AZEK Closed-Joint Cladding or Trim products as it may discolor and permanently damage the surface.
- To clean AZEK Closed-Joint Cladding, use TimberTech<sup>®</sup> DeckCleaner™ with a stiff natural fiber brush, or another all purpose cleaner such as Simple<sup>®</sup> Green.
- Always read the cleaning products manufacturer's specific information before using any product on your AZEK Closed-Joint Cladding and follow their instructions. It is also a good idea to test the cleaner on a scrap piece or inconspicuous area of the wall to make sure it does not harm the surface.
- **WARNING:** Keep children and pets away from cleaning products on the surface of Open-Joint Cladding until it is dry.
- \*Note that composite deck and composite cladding cleaners such as Corte Clean<sup>®</sup>, Thompson's<sup>®</sup> Water Seal<sup>®</sup> Oxy Action, Olympic<sup>®</sup> Premium Deck Cleaner, or other cleaners specified as composite deck cleaners, in powder or liquid form, **SHOULD NOT** be used with AZEK Closed-Joint Cladding or Trim. AZEK Closed-Joint Cladding is a PVC-based polymer, not a wood/plastic composite.
- These guidelines may not encompass all installation, care and maintenance topics. For additional questions about AZEK Closed-Joint Cladding installation, care or maintenance, call 1-877-ASK-AZEK (1-877-275-2935).

## Warranty

AZEK Building Products are made exclusively from technologically advanced materials designed to provide years of enjoyment. AZEK Closed-Joint Cladding products are covered by a Limited Lifetime Warranty for residential applications. The warranty covers defects resulting in blistering, peeling, flaking, cracking, splitting, cupping, rotting or structural defects from termites or fungal decay. AZEK Closed-Joint Cladding products are also covered by a 30 year limited residential fade and stain warranty. Visit [AZEKexteriors.com/warranty](http://AZEKexteriors.com/warranty) to view complete warranty information.







# Installing AZEK® Closed-Joint Cladding

---

## Using TimberTech® Porch Products

**AZEK Building Products**  
1330 West Fulton, Suite 350  
Chicago, Illinois 60607

**AZEKexteriors.com • (877) ASK-AZEK (877) 275-2935**